

たしざん(2)

ねん くみ

なまえ

19

■ つみきを見ながらたしざんをしましょう。

①

$$\begin{array}{r} 3 \\ + \\ 8 \\ \hline \end{array}$$

+

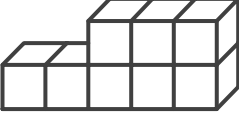

||

②

$$\begin{array}{r} 4 \\ + \\ 7 \\ \hline \end{array}$$

+

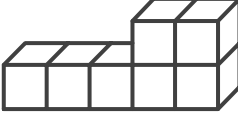

||

③

$$\begin{array}{r} 4 \\ + \\ 9 \\ \hline \end{array}$$

+

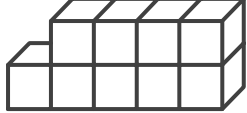

||

④

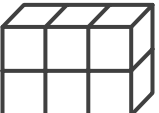
$$\begin{array}{r} 6 \\ + \\ 7 \\ \hline \end{array}$$

+



||

⑤

$$\begin{array}{r} 2 \\ + \\ 9 \\ \hline \end{array}$$

+

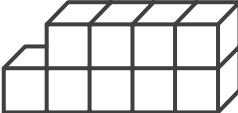

||

⑥

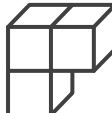
$$\begin{array}{r} 3 \\ + \\ 9 \\ \hline \end{array}$$

+

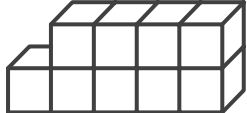

||

⑦

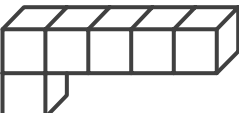
$$\begin{array}{r} 6 \\ + \\ 9 \\ \hline \end{array}$$

+

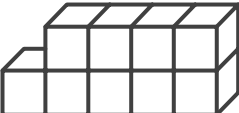

||

⑧

$$\begin{array}{r} 6 \\ + \\ 6 \\ \hline \end{array}$$

+



||

⑨

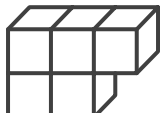
$$\begin{array}{r} 5 \\ + \\ 8 \\ \hline \end{array}$$

+

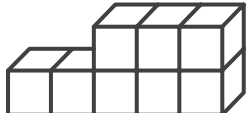

||

たしざん(2)

ねん くみ

なまえ

/ 9

■ つみきを見ながらたしざんをしましょう。

①

$$\begin{array}{r} 3 \\ + \\ 8 \\ \hline \end{array}$$

+

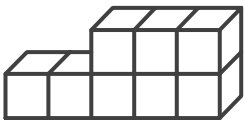

||

11

②

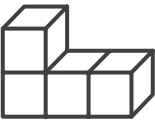
$$\begin{array}{r} 4 \\ + \\ 7 \\ \hline \end{array}$$

+



||

11

③

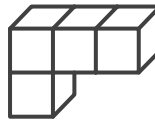
$$\begin{array}{r} 4 \\ + \\ 9 \\ \hline \end{array}$$

+

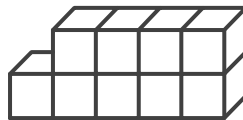

||

13

④

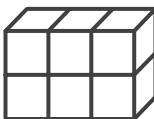
$$\begin{array}{r} 6 \\ + \\ 7 \\ \hline \end{array}$$

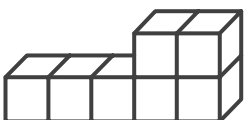

+



||

13

⑤

$$\begin{array}{r} 2 \\ + \\ 9 \\ \hline \end{array}$$

+

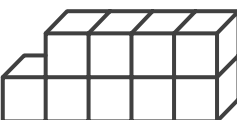

||

11

⑥

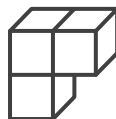
$$\begin{array}{r} 3 \\ + \\ 9 \\ \hline \end{array}$$

+

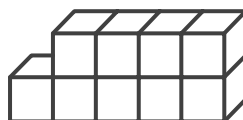

||

12

⑦

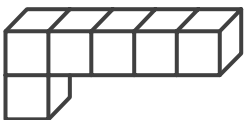
$$\begin{array}{r} 6 \\ + \\ 9 \\ \hline \end{array}$$

+

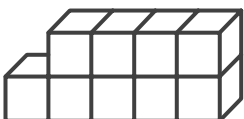

||

15

⑧

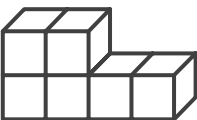
$$\begin{array}{r} 6 \\ + \\ 6 \\ \hline \end{array}$$

+

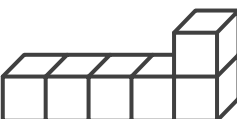

||

12

⑨

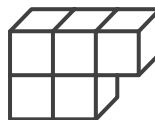
$$\begin{array}{r} 5 \\ + \\ 8 \\ \hline \end{array}$$

+

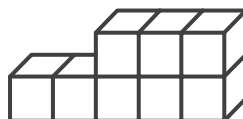

||

13