

三角形の角の大きさ

年 組 名前

19

■ 次の三角形の **あ** の角の大きさをそれぞれ答えましょう。

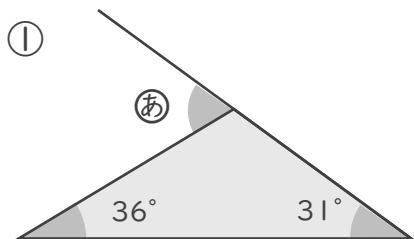
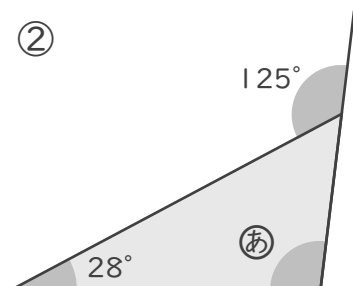
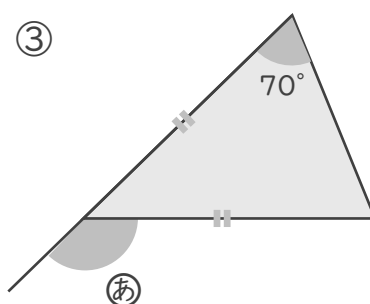
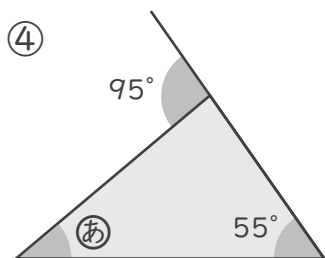
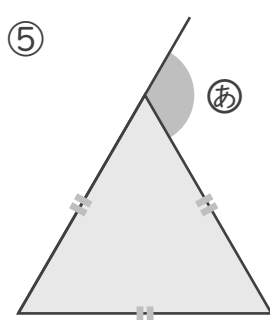
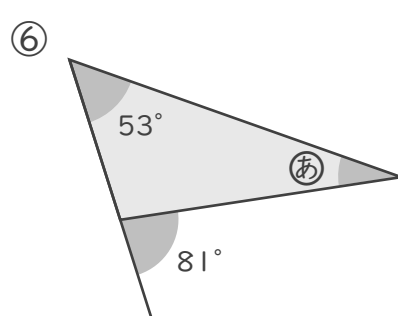
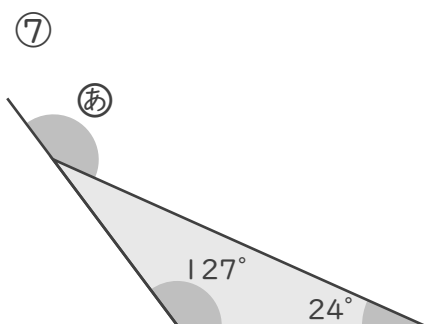
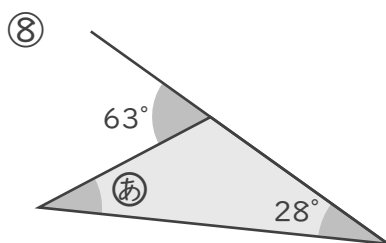
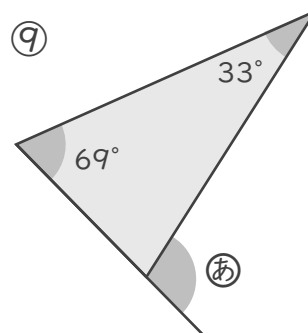

 °

 °

 °

 °

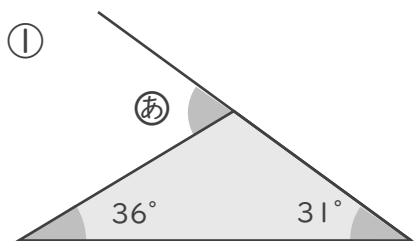
 °

 °

 °

 °

 °

三角形の角の大きさ

年 組 名前

19

■ 次の三角形の (あ) の角の大きさをそれぞれ答えましょう。



67 °

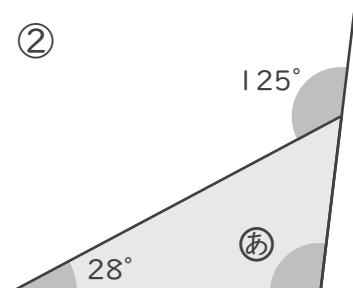

97 °

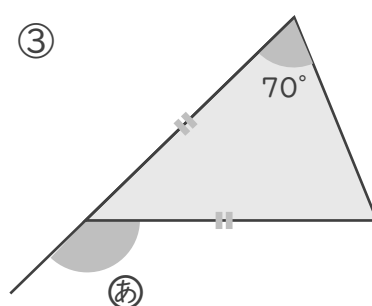

140 °

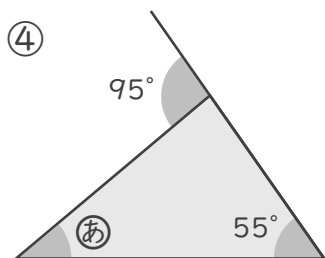

40 °

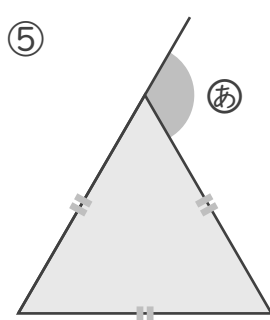

120 °

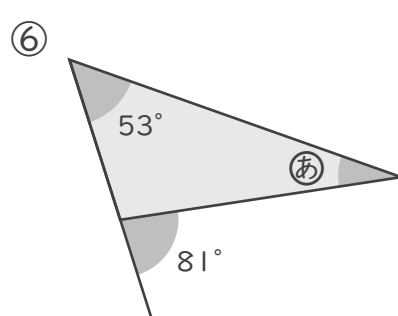

28 °

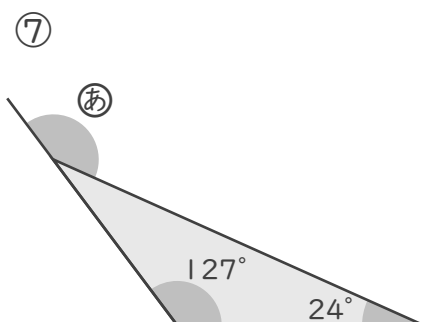

151 °

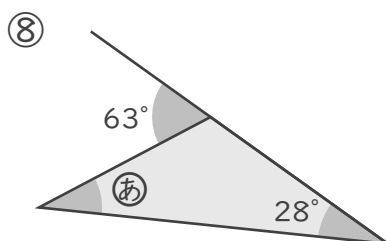

35 °

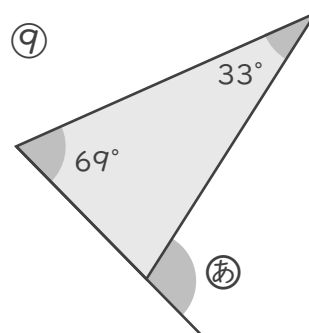

102 °